

Flush Diaphragm Submersible Liquid Level Sensor



AST4520



The AST4520 Flush Submersible liquid level sensor is the cost effective solution for level monitoring of turbulent tanks with viscous media. Approved to **UL/ cUL913 Class 1 Division 1 IS, Groups C and D with an approved barrier**, the product ensures a safe, reliable source for level measurement. The AST4520 is also certified to ATEX Class I Zone 0 Exia IIB T4 Ga (Ta = -40°C to +80°C).

The AST4520 is offered with pressure ranges from 0-2.5 to 0-15 PSIG. The AST4520 steel cage front end design allows for proper flow of liquids while keeping the sensor at the bottom of the tank or well. With an engraved stainless steel housing and Kynar PVDF cable, this sensor is built to handle the toughest environments.

Benefits

- Engraved 316L Housing
- Protective Steel Cage Assembly
- Kynar PVDF Cable
- Compatible with Wide Variety of Chemicals
- Ruggedly Designed for Harsh Waste Water Environments
- Suitable for Waste, Salt, Brackish, or Fresh Water Systems
- EMI/RFI and Reverse Polarity Protection
- Lightning and Surge Protection
- Competitively Priced for OEM Applications
- ABS (American Bureau of Shipping) Approved

Applications

- Lift Stations - Wastewater, Storm Water, Industrial Applications
- Food Tanks
- Viscous Media Tanks
- Heavy Oil

*For UL certified barrier drawing, see A01657.
For CSA certified barrier drawing, see A08949.*

Environmental Data

Temperature

Operating	-40 to 80°C (-40 to 176°F)
Storage	-40 to 100°C (-40 to 212°F)

Thermal Limits

Compensated Range	0 to 55°C (32 to 131°F)
TC Zero	<±1.5% of FS
TC Span	<±1.5% of FS

Other

Shock	100G, 11 msec, 1/2 sine
Vibration	10G peak, 20 to 2000 Hz.
EMI/RFI Protection:	Yes
Rating:	IP-68

Performance @ 25°C (77°F)

Accuracy*	< ±0.25% BFS
Stability (1 year)	±0.25% FS, typical
Over Range Protection	2X Rated Pressure
Burst Pressure	5X or 1,250 PSI (whichever is less)
Pressure Cycles	> 50 Million

Electrical Data

	Output	4-20mA	1-5VDC
Excitation		10-28VDC	10-28VDC
Output Impedance		>10k Ohms	<100 Ohms, Nominal
Current Consumption:		20mA, typical	<10mA
Bandwidth		(-3dB): DC to 250 Hz	(-3dB): DC to 1kHz
Output Noise:		-	<2mV RMS
Zero Offset:		<±1% of FS	<±1% of FS
Span Tolerance:		<±2% of FS	<±1.5% of FS
Output Load:		0-800 Ohms@10-28VDC	10k Ohms, min
Reverse Polarity Protection		Yes	Yes

Ordering Information

AST4520

Y

00005

P

4

X

1

353

-SS

Series Type

Process Connection

Y= G1/2 with steel cage

T= G1/2 flush diaphragm without steel cage

Pressure Range

Insert 5-digit pressure code

Pressure Unit

H= Inches H2O P= PSI

Outputs

3= 1-5V 4= 4-20mA (2 wire loop powered)

Electrical

X= Optional Length (see options)

Wetted Material

1 = 316L Sensor / 304 SS Housing / Kynar Cable

Options Cable Lengths:

353 = 25 ft. (7.62 m)

354 = 50 ft. (15.24 m)

355 = 75 ft. (22.86 m)

Approval

(Left Blank)= UL ANSI/ISA 12.12.01 Class I Div 1 Intrinsically Safe Groups C, D (formerly UL913)

-SS= Add "-SS" for CSA157 Class I Div 1 Groups C, D Intrinsically Safe and ANSI/ISA 12.27.01 Single Seal Approval and SIRAATEX Exia IIB Class I, Zone 0, T4

*Note: CSA approved products require case/earth ground electrical connection.
See wiring installation sheet for further details*

Pressure Ranges

	Gauge PSIG	Pressure Code	Feet of Water Column @ 4°C (approx.)
AST4520	0-15	00015	34.60
	0-10	00010	23.07
	0-7.5*	00208*	17.30
	0-5	00005	11.53
	0-2.5*	00069*	5.77

*2.5 and 7.5 PSI Sensor must be ordered in inches of H₂O.

Flush Diaphragm Submersible Liquid Level Sensor



AST4520

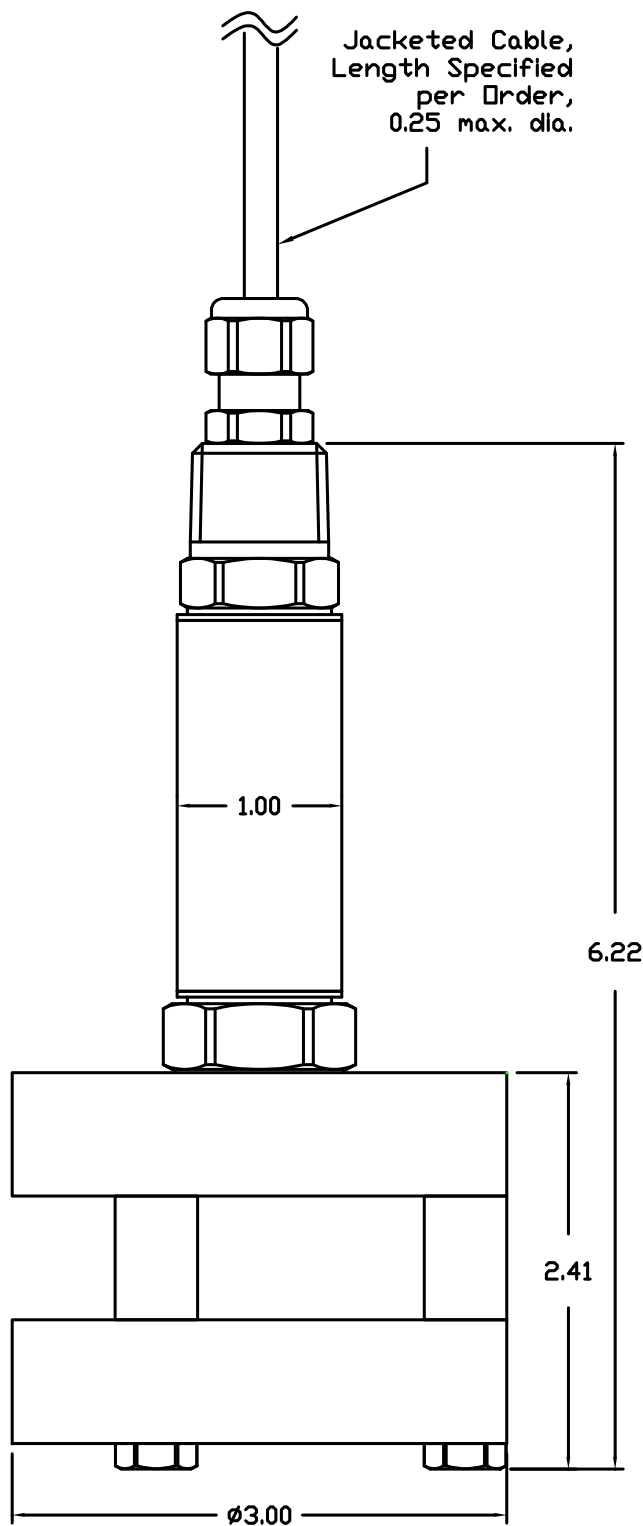

American Sensor Technologies · 450 Clark Dr., Mt. Olive, NJ 07828 · phone (973) 448-1901 · fax (973) 448-1905 · email: info@astsensors.com

© 2014 American Sensor Technologies Inc. AST4520 06/18/2014.
t notice.



+33 (0)1 46 91 93 32 **Capteurs et Systèmes de mesure**

59, rue Émile Deschanel · 92400 COURBEVOIE · France · Fax : 33 (0)1 46 91 93 39 · contact@pm-instrumentation.com

Flush Diaphragm Submersible Liquid Level Sensor



AST4520

UL Approved Barrier Installation / A01657

CSA Approved Barrier Installation / A08949

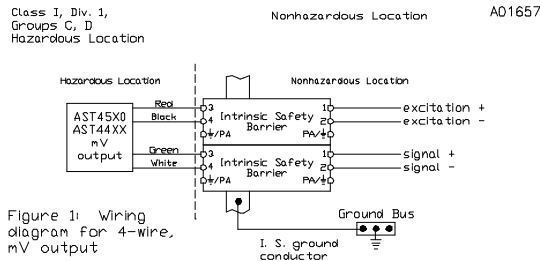

Figure 1: Wiring diagram for 4-wire, mV output

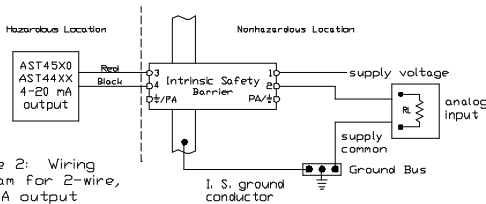

Figure 2: Wiring diagram for 2-wire, 4-20mA output

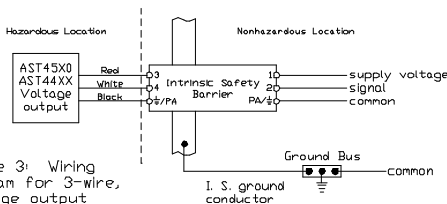

Figure 3: Wiring diagram for 3-wire, Voltage output

The transducers listed below are designed for installation in a Class I, Division 1, Groups C and D, Division 1 hazardous location when connected to Associated Apparatus as described in note 1.

Entity Parameters

$V_{max} = 28Vdc$
 $I_{max} = 175mA$ I_{max} is the total current available from the Associated Apparatus under any condition.
 $C_1 = 0.44\mu f$
 $L_1 = 0$

Notes:

1. Associated Apparatus shall provide intrinsically safe connections which meet the following parameters.

$$V_{oc} \text{ or } V_t \leq V_{max}$$

$$I_{sc} \text{ or } I_t \leq I_{max}$$

$$C_o \geq C_1 + C_{cable}$$

$$L_o \geq L_1 + L_{cable}$$

2. Control Room apparatus shall not generate in excess of 250V (U_{max}).

3. Installation should be in accordance with Article 504 in the National Electrical Code, ANSI/NFPA 70.

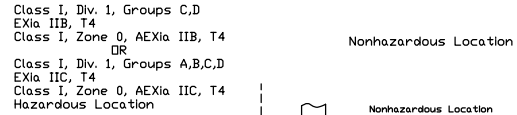

Figure 1: Wiring diagram for 4-wire, mV output

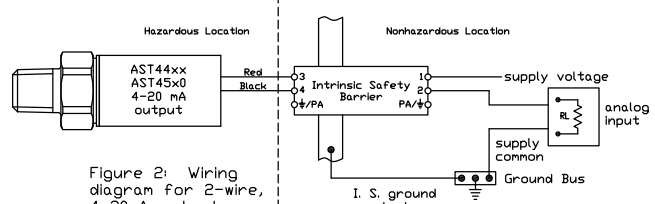

Figure 2: Wiring diagram for 2-wire, 4-20mA output

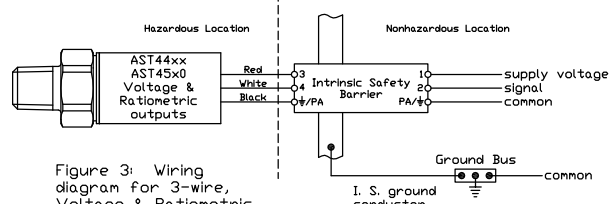

Figure 3: Wiring diagram for 3-wire, Voltage & Ratiometric outputs

Entity Parameters

Models AST4400, AST44LP, AST4500, AST4510, AST4520, AST4530
 Class I, Div. 1, Groups C,D; EXIa IIB, T4; Class I, Zone 0, AEXIa IIB, T4
 $V_{max} = 28Vdc$

Model AST4401
 Class I, Div. 1, Groups A,B,C,D; EXIa IIC, T4; Class I, Zone 0, AEXIa IIC, T4
 $V_{max} = 14.5Vdc$

4-20mA with integral connector	4-20mA with upto 1000ft of integral cable	All EXCEPT 4-20mA with integral connector	All EXCEPT 4-20mA with upto 150ft of integral cable
$P_{max} = 625 mW$ $I_{max} = 93 mA$ $C_1 = 0.391 \mu f$ $L_1 = 0$	$P_{max} = 625 mW$ $I_{max} = 93 mA$ $C_1 = 0.434 \mu f$ $L_1 = 155 \mu H$	$P_{max} = 625 mW$ $I_{max} = 93 mA$ $C_1 = 0.643 \mu f$ $L_1 = 0$	$P_{max} = 625 mW$ $I_{max} = 93 mA$ $C_1 = 0.649 \mu f$ $L_1 = 23.3 \mu H$

- For installation in accordance with Fig 2, barrier must be a CSA Certified, Single Channel grounded Shunt-Diode Zener Barrier or a Single Channel Isolating Barrier.
- For installations in accordance with Figs. 1 and 3, one dual-channel or two single-channel barriers may be used, where in either case, both channels have been Certified for use together with combined entity parameters.
- The following conditions must be satisfied:

$$V_{oc} \text{ or } U_o \leq V_{max}$$

$$I_{sc} \text{ or } I_o \leq I_{max}$$

$$P_o \leq P_i \text{ (if applicable)}$$

$$C_a \text{ or } C_o \geq C_1 + C_{cable}$$

$$L_a \text{ or } L_o \geq L_1 + L_{cable}$$
- Maximum non-hazardous area voltage must not exceed 250 V.
- Canadian installations should be in accordance with Canadian Electrical Code, Part I. U.S. installations should be in accordance with Article 504 in the National Electrical Code, ANSI/NFPA 70.
- A grounding method is not provided by the manufacturer as part of the integral design of the Transducer. For units which are connected through a grounded shunt diode safety barrier, ensure that the transducer is mounted to a surface which is at the same potential as the barrier ground.
- See user manual for installation conditions.