

WTS & BTS

Telemetry Systems

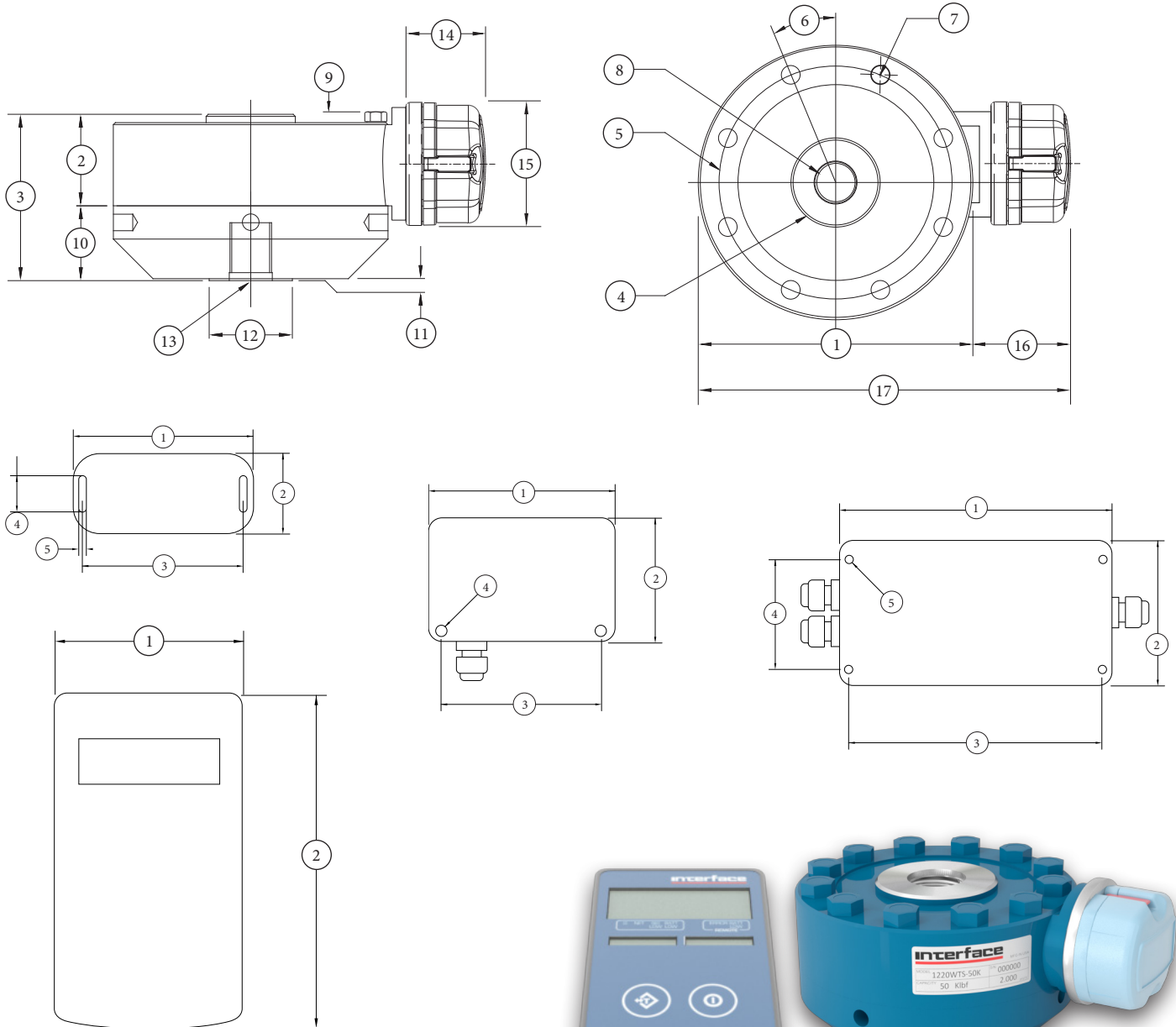

WTS & BTS Telemetry Systems v1.0 02-11-2020

interface
FORCE MEASUREMENT SOLUTIONS

The World Leader in Force Measurement Solutions™



System Benefits



- ✓ Long Battery Life
- ✓ Use Own Device
- ✓ Low Cost
- ✓ Android & iOS App
- ✓ Upgrade Path

- ✓ High Accuracy
- ✓ High Resolution
- ✓ IP Rated Enclosures
- ✓ OEM Options
- ✓ Strain or Load
- ✓ Cell Input



- ✓ High Speed
- ✓ Modular System
- ✓ Long Range
- ✓ Windows Software
- ✓ Maximum Devices
- ✓ Multiple Input Types

System Benefits

Bluetooth® Telemetry System



Instant access to close range strain bridge input measurements via phone or tablet. Connect up to 12 sensors to a single mobile device or to multiple mobile devices.

The BTS-AM-1 is a Bluetooth Low Energy (BLE) strain bridge transmitter module that provides access to high quality measurements on a mobile platform such as a phone or tablet. The delivery mechanism is BLE which utilizes the flexibility and availability of Bluetooth receivers while maintaining the low power requirements of embedded systems. BTS is built upon two complimentary principles of BLE: 1) broadcast advertising data which enables users to deliver the same data to multiple receivers simultaneously and 2) low power paired connections which can be used in a point to point system.

Wireless Telemetry System



Powerful and easily expandable for measuring multiple sensor types. Connects with up to 100 sensors up to half a mile range. Supported by powerful configuration software with data logging and visualization for local or remote access.

The Interface WTS, sensor transmitters, receivers, and displays provide high accuracy, high quality measurement with simple, yet powerful configuration and monitoring software. The WTS gives sensor manufacturers and integrators the complete flexibility to build their own sensor modules around it. The system easily replaces wired systems, reducing installation and maintenance costs.



WTS 1200 Standard Precision Wireless

Up to 3,000K lbf
Up to 13.3 kN

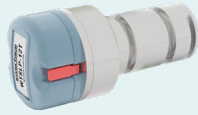

WTSLP Wireless Stainless Steel Load Pin

Up to 3,000K lbf
Up to 13.3 kN



WTSTL Wireless Tension Link

11K to 220K lbf
5 to 100 MT



WTSSHK-B Wireless Crosby™ Bow Load Shackle

26.5K and 265K lbf
12 to 120 MT



WTSSHK-B-HL Wireless Bow Load Shackle

265K to 2205K lbf
120 to 1K MT



WTSSHK-B-JR Wireless Crosby™ Bow Load Shackle

7.17K to 20.9K lbf
3.25 to 9.5 MT



WTSSHK-D Wireless Crosby™ Load Shackle

26.5K to 77.2K lbf
12 to 35 MT



IAHD-1 Advanced Wireless Handheld Display with Audible Alarm

Rugged and versatile digital display



WTS-AM-1E Wireless Strain Bridge Transmitter Module
For Strain Bridge Input



WTS-AM-1F Wireless Strain Bridge Transmitter Module
For Fast Measurements



WTS-AM-2 Wireless Voltage Sensor Transmitter
For Voltage Input



WTS-AM-3 Wireless 4-20 mA Transmitter Module
For mA Input



WTS-BS-1 Wireless Handheld Display For Unlimited Transmitters
Roams Between Transmitters in Range



WTS-BS-1-HA Wireless Handheld Display for Multiple Transmitters
Provides Summation of Up to 12 Transmitters



WTS-BS-1-HS Wireless Handheld Display for Single Transmitters
Simple Operation



WTS-BS-3E Wireless Base Station with USB Interface
Includes WTS Toolkit Software and Log 100 Software



WTS-BS-4 Wireless Base Station with USB Interface in Industrial Enclosure
Includes WTS Toolkit Software and Log 100 Software



WTS-BS-5 Wireless Analog Output Receiver Module
Provide Analog Output for WTS Acquisition Modules



WTS-BS-5DT Wireless Analog Output Receiver Module
Provide Analog Output for WTS Acquisition Modules



WTS-BS-6 Wireless Telemetry Dongle Base Station
Includes WTS Toolkit Software and Log 100 Software



WTS-LD1 Wireless Large LED Display
Large Screen with 4-digit
4 in (102 mm) LED display



WTS-LD2 Wireless Large LED Display
Large Screen with 6-digit
4 in (102 mm) LED display



WTS-GW1 Wireless Gateway with Modbus and ASCII Serial Output
Capable of Gathering Data from
Up to 100 Acquisition Modules

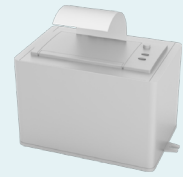

WTS-PR1 Wireless Telemetry Printer
Prints Screen from the
Handheld WTS-BS-1-HA



WTS-RM1 Wireless Relay Output Receiver Module
Accepts Up to 16 Devices



WTS-SO Wireless Interface with ASCII Serial Output
Serial Output to Printer,
Display, PC or PLC



WTS-WSS Wireless Wind Speed Transmitter Module
Constantly Monitors
Average Wind Speed



WTS-AR Wireless Repeater Module
Extends and Enhances
Range of WTS Devices

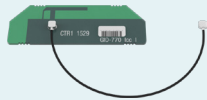

WTS-ANTA PCB Antenna
Designed to be fitted
inside a plastic enclosure



WTS-ANTB Whip Antenna
Fixed 90 degree elbow designed
for mounting externally



WTS-ANTC Whip Antenna
Variable angled elbow
for mounting externally



WTS-ANTD Puck Antenna
Suitable for applications requiring
a low physical profile and high gain



WTS-ANTE Puck Antenna
Designed for mounting externally
with a low physical profile



WTS-BC1 Telemetry Charger Module
Lithium battery charger module
Compatible with both WTS and BTS



BTS-AM-1 Bluetooth Telemetry System
"AA" Battery Powered Bluetooth
Strain Gage Transmitter



BTS-OEM-1 Bluetooth Telemetry System
OEM Bluetooth Strain
Gage Transmitter



Log 100 Software
Display, Logging, Graphing,
& Mapping Software

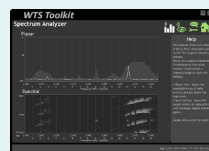

WTS Toolkit
Setup & Scaling, Logging,
& Graphing Software



Interface Telemetry Cloud Platform
Cloud platform offers browser
based access to data collected



BTS Toolkit
Free iOS and Android App

TRANSMITTERS

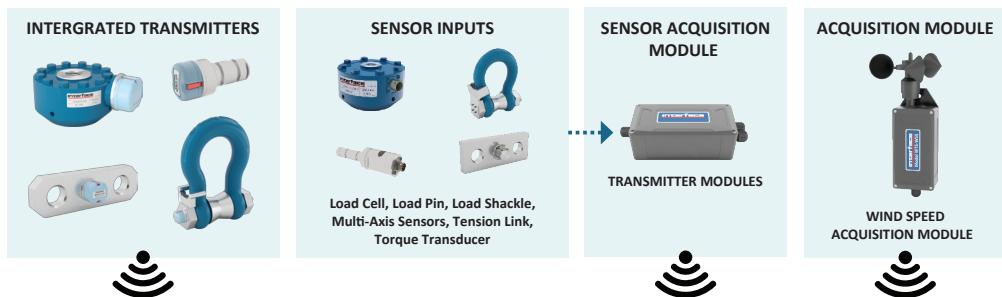

RECEIVERS

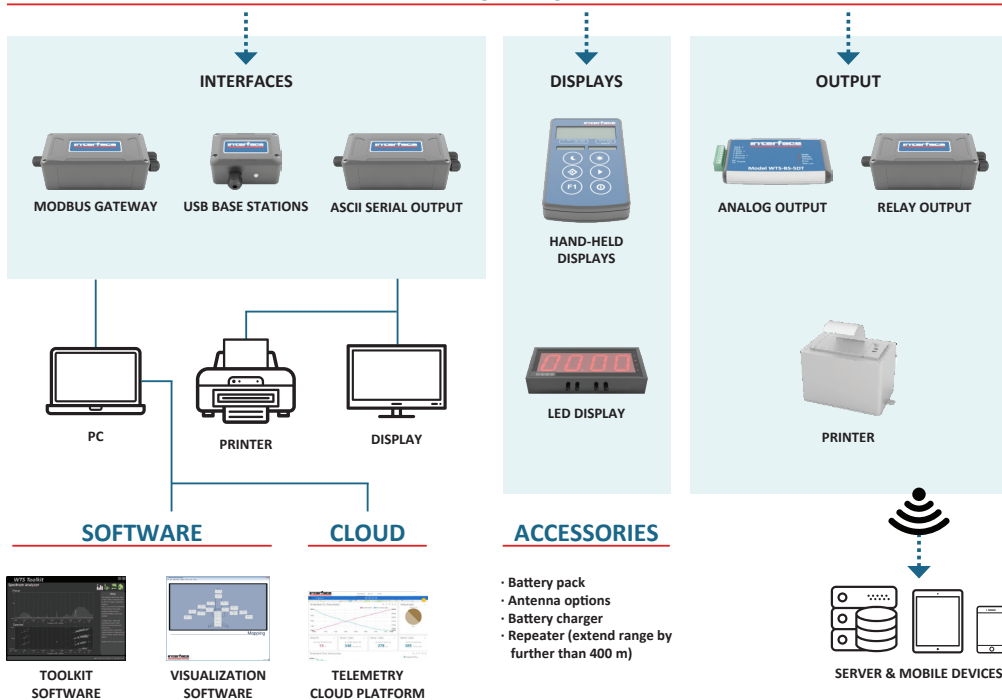

Software, Apps, & Cloud Platform

- WTS Toolkit
- BTS Toolkit
- Log 100
- Interface Telemetry Cloud Platform

WTS Toolkit

The WTS Toolkit is a software tool that allows communication with the WTS range of 2.4GHz telemetry products. A suitable telemetry to PC interface will be required such as a base station.

BTS Toolkit

A free iOS and Android app is available for download, which enables users to create dashboards with varying degrees of detail based on application requirements. It enables BTS systems to be visualized on phones and tablets by using digital displays, gages, tanks and charts. Displayed data can be defined as mathematical expressions consisting of readings from multiple transmitters, functions and constants. The app also facilitates BTS module configuration and calibration.

Log 100

Log 100 has been designed to allow the logging and visualization of up to 100 channels of data from the WTS Wireless Telemetry range of sensor transmitters. This software is free to download and allows users to build a visual representation of a system and assign live readings. The built in web server provides a summary view page to other computers, tablets, iPads and smart phones etc. using a standard browser.

Interface Telemetry Cloud Platform

Our new Cloud platform offers browser based access to data collected from the WTS telemetry instrumentation anywhere, at any time. Send data to the Cloud from our WTS range of hardware and software gateway solutions.

Interface WTS & BTS Telemetry Systems

- Bluetooth®
- Wireless
- Acquisition Modules
- Repeater Modules
- Telemetry Antennas
- Base Stations
- ASCII Serial Output
- LED Displays
- Repeater Modules
- Modbus
- LED Displays
- Wireless Telemetry Printers
- Relay Output Receivers
- Wind Speed Transmitters
- Load Cells
- Load Pins
- Tension Links
- Shackles

*Interface force measurement
Wireless and Bluetooth
Telemetry Systems are available
in many design configurations
for project designs requiring the
highest performance.*

**To learn more about
the Interface products
or force measurement
solutions call
480-948-5555.**

Interface is the world's trusted leader in technology, design and manufacturing of force measurement solutions.

Our clients include a "who's who" of the aerospace, automotive and vehicle, medical device, energy, industrial manufacturing, test and measurement industries.

Interface engineers around the world are empowered to create high-level tools and solutions that deliver consistent, high quality performance. These products include load cells, torque transducers, multi-axis sensors, wireless telemetry, instrumentation and calibration equipment.

Interface, Inc., was founded in 1968 and is a US-based, woman-owned technology manufacturing company headquartered in Scottsdale, Arizona.

The Bluetooth® word mark and logos are registered trademarks owned by the Bluetooth SIG, Inc. and any use of such marks by Interface, Inc. is under license. Other trademarks and trade names are those of their respective owners.

interface
FORCE MEASUREMENT SOLUTIONS

7418 East Helm Drive, Scottsdale, AZ 85260 • 480.948.5555 • interfaceforce.com